

ZEROWATER.
THE SCIENCE OF THE PUREST TASTING WATER™

**QUICK
GUIDE**

**ENJOY
THE PUREST
TASTING WATER.
EVERY POUR.**

THANK YOU FOR PURCHASING
AN AUTHENTIC ZEROWATER® PRODUCT.

WE STRIVE FOR ZERO.

2-PMPHLTG4-01

COVER + BACK

ASSEMBLE YOUR ZEROWATER QUICKLY AND EASILY

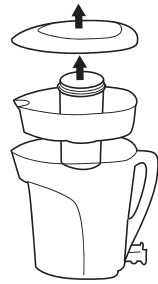

STEP 1

Remove the TDS meter from packaging and test your tap water. Compare to TDS chart on page 3 to help give a gauge of filter life.
*For Ready-Read products detach integrated meter from device.

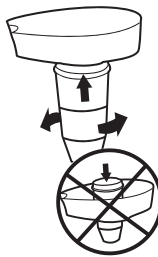

STEP 2

Remove lid and reservoir from device. Unwrap filter and remove branded film or blue cap (where applicable).



STEP 3

Clean your device in warm water using mild soap then rinse and dry thoroughly. Then rinse the exterior of your filter with warm water for 30 seconds.
*Reminder please rewash your device with each filter change.



STEP 4

Twist filter into the bottom of the reservoir. Do not drop the filter in from above. Tighten until there is a complete seal between the filter, blue O-ring and reservoir.

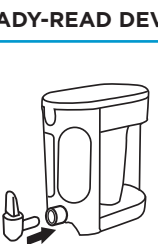

STEP 5

Fill reservoir with cold tap water (directly on to the filter) and place lid on top. Allow all the water to pass through the filter before filling again.

STEP 6

Fill your cup and enjoy.

STEP 7

Once your TDS meter reads 006 that means it is time to change your filter.

*For Ready-Read products simply turn on your meter (while it is docked within the spigot) during dispensing and get your instant read, every time.

READY-READ DEVICES ONLY:



Align spigot with hole. Push into place until locks engage.

Helpful Hint: Wet blue O-ring prior to assembly for easier fit.

1

ZERO DISSOLVED SOLIDS GUARANTEED*

ALL THE COMPARISONS YOU CAN MAKE

USE THE TDS METER TO COMPARE ZEROWATER TO TAP WATER AND OTHER WATER FILTERS

Dissolved solids are salts and minerals that may affect water taste and appearance; they are not harmful to consume. Conventional 2-stage filters remove only about half of the dissolved solids typically present in tap water.

1. TEST YOUR TAP WATER
2. TEST YOUR ZEROWATER FILTERED WATER
3. TEST YOUR OLD PITCHER

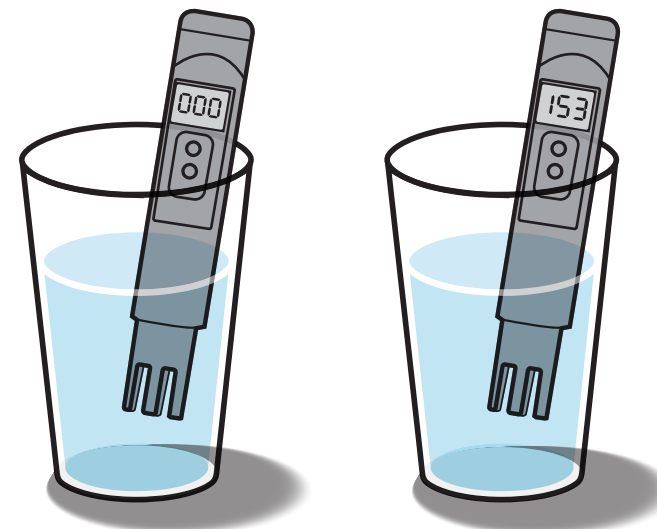

Change your filter when the meter reads 006 for the product to continue to perform as represented.

*until filter exhausted 2

SPREAD 1

GET THE MOST OUT OF YOUR TDS METER

The included TDS meter measures the Total Dissolved Solids in PPM. We suggest you test your water regularly and change your filter when the meter reads 006 to always drink the purest tasting water.

FOR PRODUCTS WITH READY-READ TECHNOLOGY:

Simply turn on your meter (while it is docked within the spigot) during dispensing and get your instant read, every time.

FOR PRODUCTS WITHOUT READY-READ TECHNOLOGY:

Remove cap, turn on, submerge in water, change filter when it reads 006 or higher.

REPLACEMENT BATTERY INSTRUCTIONS:

Meter includes (2) alkaline batteries. Do not mix old and new batteries. Do not mix alkaline, standard or rechargeable batteries.

TDS meters included with select ZeroWater pitchers/dispensers.

TAP WATER TDS	DESCRIPTION	EXPECTED DURATION OF ZEROWATER FILTER
000-001	MEETS FDA STANDARDS FOR TDS LEVELS IN PURIFIED BOTTLED WATER. NO KNOWN MUNICIPALITIES.	N/A
002-050	NATURALLY OCCURRING IN ONLY A FEW CITIES. CAN STILL HAVE DANGEROUS IMPURITIES SUCH AS LEAD.	40 GALLONS OR MORE
051-200	TDS LEVELS WITHIN TYPICAL RANGE. MOST WATER IN THE USA FALLS INTO THIS GROUPING.	25 TO 40 GALLONS
201-300	HIGH TDS LEVEL. EXPECT SLIGHTLY LOWER CAPACITY.	15 TO 25 GALLONS
301-400	HIGH TDS LEVEL. EXPECT SLIGHTLY LOWER CAPACITY.	8 TO 15 GALLONS
401+	THE HIGHEST TDS WATER. EXPECT LOWER CAPACITY WHEN REDUCING YOUR WATER TO 000.	8 GALLONS OR LESS

The higher the influent TDS, the shorter the lifespan of the filter as the filter is working harder to remove more impurities



SCAN FOR ADDITIONAL PERFORMANCE RESULTS

LEARN HOW THE TDS METER WORKS

THE SCIENCE OF THE PUREST TASTING WATER

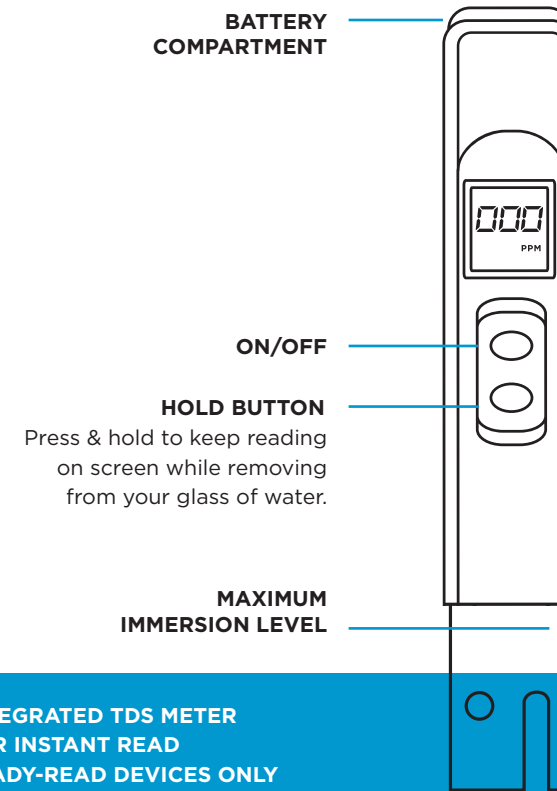

INTEGRATED TDS METER FOR INSTANT READ READY-READ DEVICES ONLY

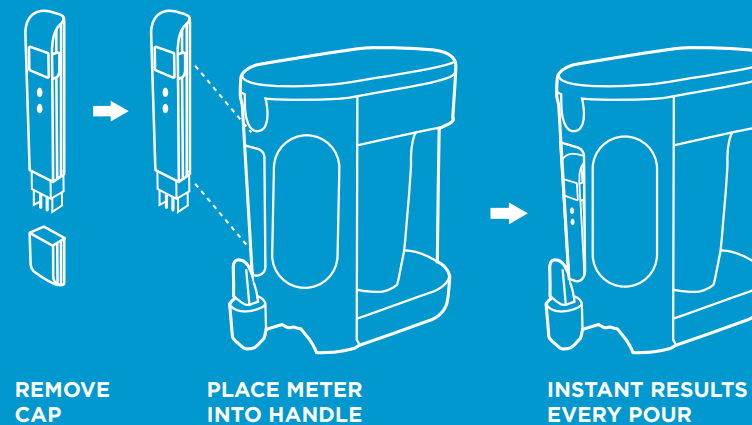

PRODUCTS MAY DIFFER SLIGHTLY FROM WHAT IS PICTURED 4

LEARN HOW YOUR 5-STAGE FILTER WORKS

- 1** FILTERS FINE PARTICLES AND SEDIMENT
- 2** FILTERS SUSPENDED SOLIDS
- 3** FILTERS ORGANIC CONTAMINANTS & STOPS BACTERIA FROM FORMING
- 4** FILTERS INORGANIC COMPOUNDS, METALS AND NON-METALS
- 5** FILTERS ULTRA-FINE PARTICLES

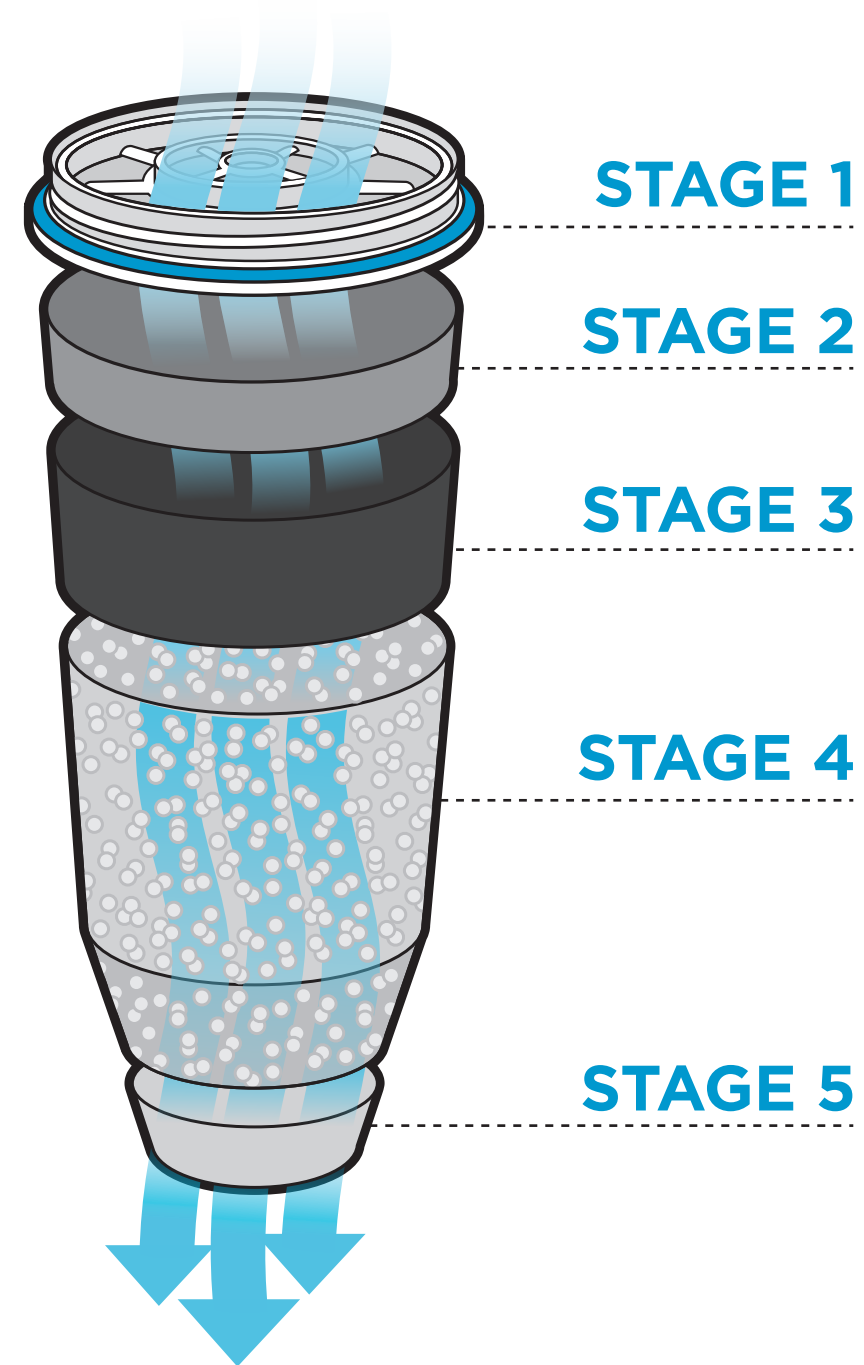

5

6

DISCOVER ZEROWATER'S PERFORMANCE AND WHY IT IS BETTER THAN THE COMPETITION

Additional performance results of ZeroWater's 5-Stage Filter vs. conventional 2-Stage Filter for Inorganic Chemicals as listed under the EPA's National Primary Drinking Water Regulations and Contaminants listed under the EPA's Secondary Drinking Water Standards.¹

METALS				
	ZEROWATER		LEADING CONVENTIONAL	
	20 GALLONS FILTERED*	40 GALLONS FILTERED**	20 GALLONS FILTERED*	40 GALLONS FILTERED**
ANTIMONY	99%	96%	99%	80%
ARSENIC III	98%	85%	63%	55%
ARSENIC V	98%	93%	94%	87%
BARIUM	99.9%	99.9%	96%	91%
BERYLLIUM	97%	97%	94%	73%
CADMIUM	97%	97%	97%	97%
CHROMIUM 3	98%	94%	93%	78%
CHROMIUM 6	99%	99%	93%	67%
COPPER	99.9%	99.9%	93%	88%
IRON	99.9%	99.9%	99%	99%
LEAD	99%	99%	85%	63%
MANGANESE	99%	99%	49%	22%
MERCURY	92%	91%	92%	87%
SELENIUM	99%	88%	79%	54%
SILVER	99.9%	96%	37%	14%
THALLIUM	99%	98%	91%	88%
ZINC	99.9%	99.9%	95%	95%

INORGANIC NON-METALS				
	ZEROWATER		LEADING CONVENTIONAL	
	20 GALLONS FILTERED*	40 GALLONS FILTERED**	20 GALLONS FILTERED*	40 GALLONS FILTERED**
ASBESTOS	99%	98%	89%	58%
CHLORINE	99%	99%	95%	89%
CYANIDE	99.9%	99%	85%	77%
FLUORIDE	99%	91%	3%	2%
NITRATE	98%	78%	48%	47%
NITRITE	99%	88%	93%	92%

¹ Test results based on NSF/ANSI testing standards of pour through devices as performed by Quality Filter Testing Laboratory, LLC, located in Williamstown, New Jersey, an independent ISO 17025 laboratory recognized by IAPMO.

ZeroWater's 5-stage filter with a rated capacity of 20 Gallons and Brita's 2-Stage Standard Filter with a rated capacity of 40 Gallons were tested in accordance with the products' recommended daily usage of 2 gallons of filtration per day. Results shown are based on an averaged calculation of each filter's test results of drinking water at a pH level of 6.5 and pH level of 8.5.

*% reduction after 20 Gallons of Filtration

**% reduction after 40 Gallons of Filtration

Brita® is a registered trademark of Brita®, L.P, which is not affiliated with Zero Technologies, LLC.

PERFORMANCE DATA

ZeroWater® PERFORMANCE DATA SHEET.

FOR MODELS: ZD-018, ZP-006, ZP-010, ZD-010RP, ZD-023-1, ZD-012RP, ZP-007RP, ZBD-040, ZD-030RP, ZR-0810N, ZR-0810GN, ZD-20RPN, ZS-011RPN, ZBD-030, ZD-022-RR, ZP-012-RR //

IMPORTANT NOTICE:

Read this Performance Data Sheet and compare the capabilities of this unit with your actual water treatment needs. It is recommended that before purchasing a water treatment unit you have your water supply tested to determine your actual water treatment needs. All contaminants reduced by this water treatment device are not necessarily in your water supply. While testing was performed under standard laboratory conditions, actual performance may vary.

This system has been tested according to NSF/ANSI 42 and NSF/ANSI 53 for reduction of the substances listed below. The concentration of the indicated substances in water entering the system was reduced to a concentration less than or equal to the permissible limit for water leaving the system, as specified in the relevant standard.

Service flow rate is 2.0 gallons per day. Operating temperature is 40-90° F. This water treatment device is intended only for use with potable water. Do not use water that is microbiologically unsafe or of unknown quality without proper disinfection before or after the system.



This system has been tested and certified by NSF International under NSF/ANSI Standards 53 and 42 for the reduction of substances

SUBSTANCE	OVERALL PERCENT REDUCTION	INFLUENT CHALLENGE CONCENTRATION (mg/L)	MAXIMUM EFFLUENT CONCENTRATION (mg/L)	MAXIMUM PERMISSIBLE EFFLUENT CONCENTRATION (mg/L)
NSF/ANSI STANDARD 53 - HEALTH EFFECTS				
CHROMIUM HEXAVALENT, PH 6.5	99.6%	0.3 ± 10%	0.003	0.050
CHROMIUM HEXAVALENT, PH 8.5	99.6%	0.3 ± 10%	0.002	0.050
LEAD, PH 6.5	99.7%	0.15 ± 10%	0.0005	0.010
LEAD, PH 8.5	95.9%	0.15 ± 10%	0.0075	0.010
MERCURY, PH 6.5	96.7%	0.006 ± 10%	0.0002	0.002
MERCURY, PH 8.5	96.0%	0.006 ± 10%	0.0004	0.002
PFOA/PFOS	94.9%	0.0015 mg/L ± 10%	0.00007	0.00007
NSF/ANSI STANDARD 42 - AESTHETIC EFFECTS				
CHLORINE	97.5%	2.0 ± 10%	0.05	50% of influent

System Tested and Certified by NSF International against NSF/ANSI Standard 42 for reduction of chlorine taste and odor and against NSF/ANSI Standard 53 for reduction of lead, chromium (Hexavalent), PFOA, PFOS and mercury.

ZEROWATER.COM

WHAT MAKES ZEROWATER. DIFFERENT?

TECHNOLOGY THAT WORKS BETTER THAN THE COMPETITION.

MAKE THE MOST OUT OF YOUR ZEROWATER PRODUCT!



DRINKING WATER

Removes virtually all TDS for the purest-tasting water — and you'll drink more of it! Perfect for your household and guests.



ICE CUBES

Get crystal clear ice cubes that last longer and make your drinks taste better. No more cloudy ice due to TDS!



COOKING

Improve the consistency of your favorite dishes and recipes by reducing hard minerals and disinfectants.



PETS

Filter your pets' water too! After all, they can be affected by some of the same contaminants that affect us.



BABY CARE

Protect infants and small children from harmful chemicals and pollutants that could affect growth and development.

11

CONNECT WITH US

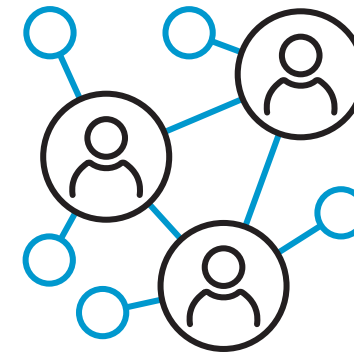

TELL US

WRITE A REVIEW ON [ZEROWATER.COM](https://www.zerowater.com)

TELL THEM

USE YOUR WATER METER TO IMPRESS FRIENDS & FAMILY

JOIN OUR MAILING LIST

FOR TONS OF SAVINGS

FOLLOW US

 [@ZEROWATERFILTER](https://twitter.com/ZEROWATERFILTER)

 [@ZEROWATER](https://www.facebook.com/ZEROWATER)

 [@ZEROWATER000](https://www.instagram.com/ZEROWATER000)

 [@ZEROWATER000FILTERS](https://www.youtube.com/ZEROWATER000FILTERS)

If you experience any problems or have additional questions, please do not hesitate to contact our dedicated, live US-based technical support team at:



PRODUCT SUPPORT
1-800-503-2939



CUSTOMERSERVICE@ZEROWATER.COM
Mon-Fri: 8am-8pm CT



LIVE CHAT
ZEROWATER.COM

SEE FULL ASSORTMENT OF PRODUCTS AT [ZEROWATER.COM](https://www.zerowater.com)

12

SPREAD 6

QUICK TIPS



GETTING STARTED

- No need to pre-rinse our filter, we have already done it for you with purified water. This can cause condensation inside the bag or lid, which is harmless.
- This also means there is no shelf life to worry about as long as the bag is not opened, and it is stored in a cool dry place.

NOT GETTING A "000" READING?

- Ensure that the filter is threaded correctly. Watch for cross-threading and ensure that the rubber gasket is seated properly.
- Make sure you are pouring your filtered water into a clean glass.
- The TDS meter may pick up trace residue from previous use or soap if not cleaned properly.

For all other issues, please contact our customer service center at 1-800-503-2939 or email customerservice@zerowater.com.

READY.
SET.
ZERO.

LIMITED WARRANTY

VESSELS & TDS METER:

Zero Technologies, LLC warrants the ZeroWater vessels & TDS meter to be free from manufacturing defects for 90 days from the date of purchase, when used in compliance with the Owner's Manual. During this 90-day period if you discover a manufacturing defect in the vessel or TDS meter (excluding the filter), we will replace the parts free of charge.

FILTER CARTRIDGE:

Zero Technologies, LLC warrants its filters to be free from manufacturing defects for 30 days from the date of purchase, when used in compliance with the Owner's Manual. During this 30-day period, if you discover a manufacturing defect in your filter, we will provide instructions on how to return the filter for laboratory testing.

If the lab determines that the filter is defective, we will replace it free of charge (minus shipping costs). If no defect is found, your filter will be returned to you, and we will not replace it.

NOTE:

This warranty does not guarantee the life of the filter for any specific period of volume of use. For more information about expected filter life, see www.zerowater.com/filtration-filter-life.aspx

To file a warranty, claim call, 1-800-503-2939 to speak with a customer service representative. Dated proof of purchase is required for any warranty claim. Every implied warranty is limited to the duration of this written warranty. Some states do not allow limitations on how long an implied warranty lasts, so the above limitation may not apply to you. This warranty gives you specific legal rights, and you may also have other rights which vary from State to State.

SAVE ON FILTERS

JOIN OUR FILTER SUBSCRIPTION PROGRAM AND SAVE UP TO 13%



SCAN, SIGN UP AND SAVE WITH OUR NO HASSLE FILTER SUBSCRIPTION PROGRAM!

Never miss a chance to change your filter on time!

SAVE NOW ON THE PUREST TASTING WATER

VISIT OUR WEBSITE FOR DAILY COUPONS

MANUFACTURER'S COUPON

EXPIRES 12/31/25

\$2⁵⁰ OFF

2-PACK or 4-PACK ZEROWATER REPLACEMENT FILTERS
store finder at zerowater.com

CONSUMER: Take this coupon to the checkout stand and save \$2.50 on a 2-Pack or 4-Pack of Zero Water Replacement Filters. Limit one coupon per store visit. Offer valid in US only. No doubling of coupon allowed. Coupon cannot be assigned, transferred or reproduced. Coupon good only on product indicated, any other use constitutes fraud. **RETAILER:** You will be reimbursed for the face value of this coupon plus .08 cents handling allowance, if submitted in compliance with Standard Coupon Redemption Policies. Manufacturer reserves the right to request invoices proving purchase of sufficient stock to cover coupons resented for redemption. Void where taxed, restricted, prohibited, or presented by other than retailers of our products. Cash Value: 1/100th of a cent. Coupon must be redeemed by 12/31/25. **MAIL TO:** PMCI \$2.50 Coupon Offer Dept. 11310, PO Box 5016, Stacy MN 55078-5016. ©2020 Zero Technologies, LLC. Coupons valid in US only.



0188781000-011337

MANUFACTURER'S COUPON

EXPIRES 12/31/25

\$2⁵⁰ OFF

2-PACK or 4-PACK ZEROWATER REPLACEMENT FILTERS
store finder at zerowater.com

CONSUMER: Take this coupon to the checkout stand and save \$2.50 on a 2-Pack or 4-Pack of Zero Water Replacement Filters. Limit one coupon per store visit. Offer valid in US only. No doubling of coupon allowed. Coupon cannot be assigned, transferred or reproduced. Coupon good only on product indicated, any other use constitutes fraud. **RETAILER:** You will be reimbursed for the face value of this coupon plus .08 cents handling allowance, if submitted in compliance with Standard Coupon Redemption Policies. Manufacturer reserves the right to request invoices proving purchase of sufficient stock to cover coupons resented for redemption. Void where taxed, restricted, prohibited, or presented by other than retailers of our products. Cash Value: 1/100th of a cent. Coupon must be redeemed by 12/31/25. **MAIL TO:** PMCI \$2.50 Coupon Offer Dept. 11310, PO Box 5016, Stacy MN 55078-5016. ©2020 Zero Technologies, LLC. Coupons valid in US only.



0188781000-011337